

IDIOMA	PT
TABELA PREÇO	
PÁG.	1/3

INTERIOR
G3P3+1V1

DIMENSÕES

COMPRIMENTO (mm)	2500(MÁX.)
LARGURA (mm)	800-1250
PROFUNDIDADE (mm)	596(+PORTA18MM)
LARGURA GUARNIÇÃO (mm)	70
OPÇÃO GUARNIÇÃO (mm)	3 OU 4 LADOS
LARGURA VÃO (mm)	LARGURA ROUPEIRO + 40
ALTURA VÃO (mm)	ALTURA ROUPEIRO + 20

REVESTIMENTOS INTERIORES
16 mm

FOLHA MADEIRA	
FOLHA MADEIRA COMPOSTA	
MELAMINA	STD

BLOCO GAVETAS
ALTURA 732 mm | LARGURA 450-1200

ACESSÓRIOS STANDARD

PORTAS

REVESTIMENTOS PORTAS
2500X650X18(MAX)

BRANCO LACADO(SOBRE CPL) PRE-LACADO(CPL E FUNDO NA CONTRA-FACE)	STD
CPL	OPCIONAL
FOLHA MADEIRA	STD
FOLHA MADEIRA COMPOSTA	STD
HPL	OPCIONAL
MELAMINA	OPCIONAL

GUARNIÇÕES
3L | 4L | SEM GUARNIÇÃO
3 LADOS
4 LADOS

ACESSÓRIOS OPCIONAIS

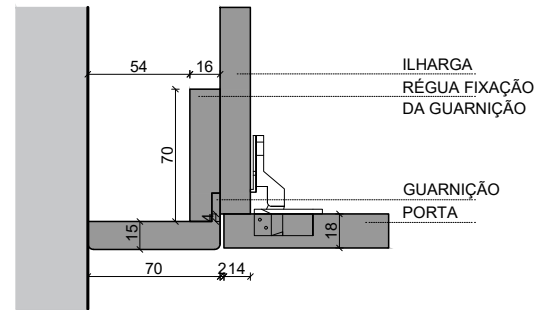
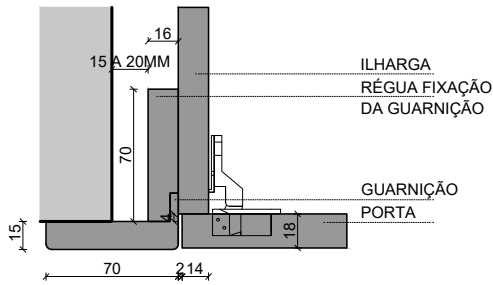
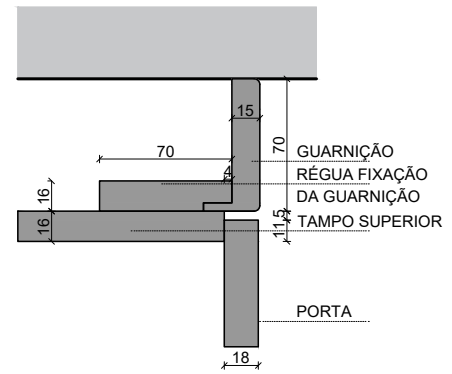
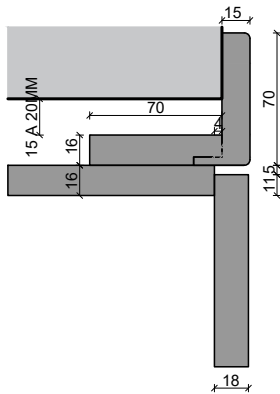
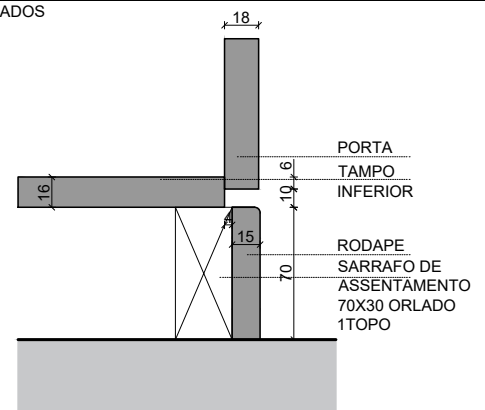
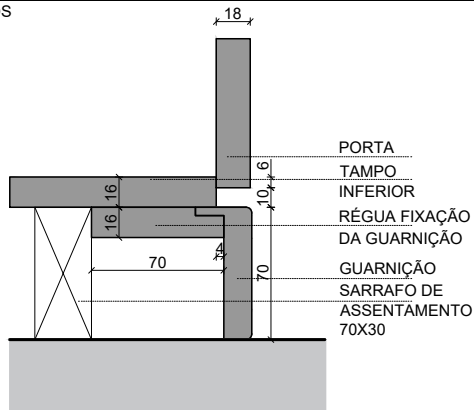
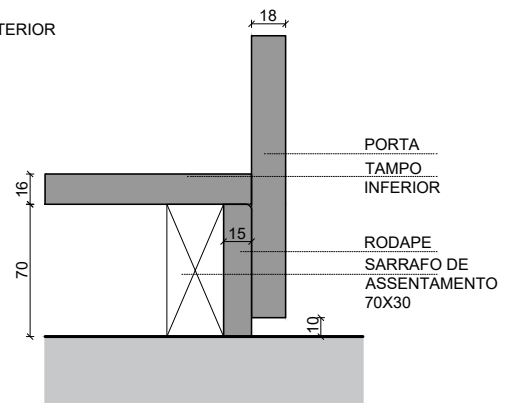
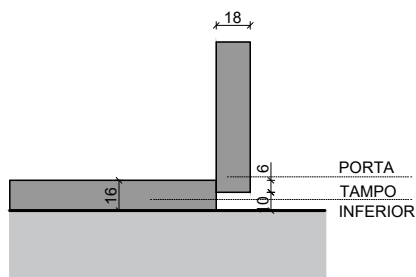
GUARNIÇÃO
REMATE LATERAL
COM GOLA
SEM GOLA

REMATE SUPERIOR
COM GOLA
SEM GOLA

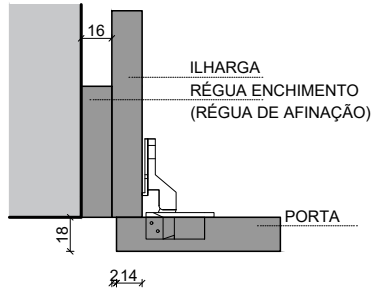
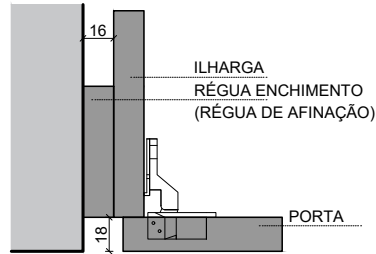
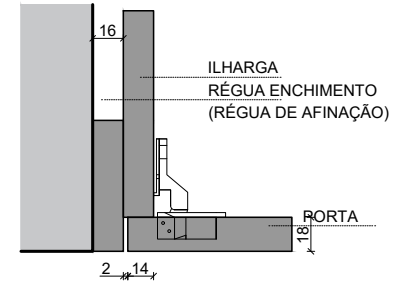
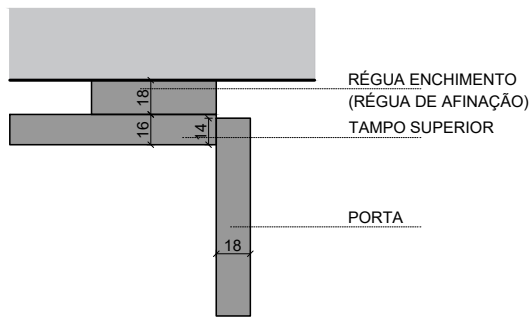
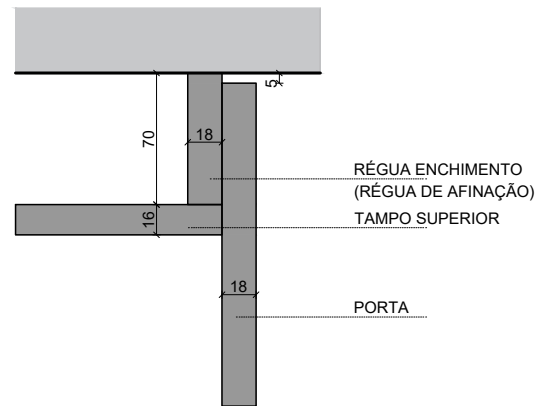
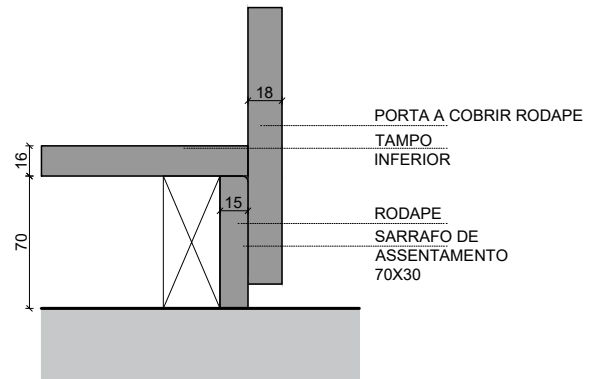
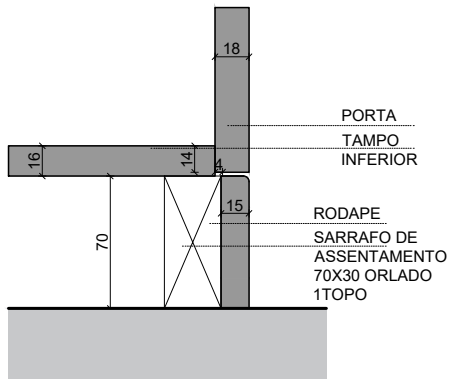
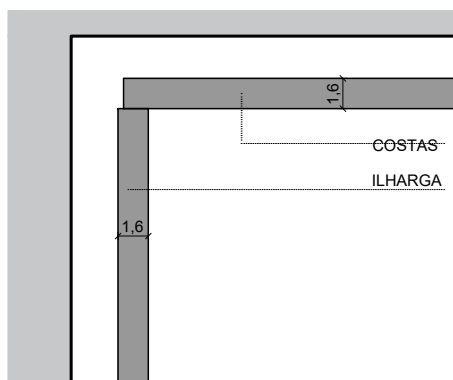
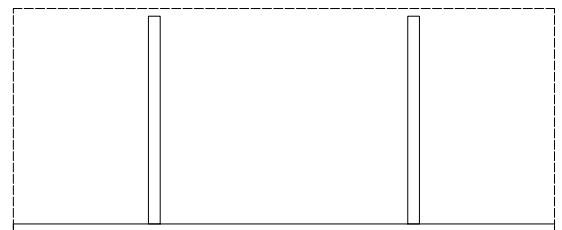
REMATE INFERIOR
GUARNIÇÃO 4LADOS
GUARNIÇÃO 3LADOS

SEM RODAPÉ
RODAPÉ INTERIOR

DIMENSÕES A FORNECER EM TOSCO

IDIOMA	PT
TABELA PREÇO	
PÁG.	2/2

REGUA ENCHIMENTO
REMATE LATERAL
REGUA ENCHIMENTO ALINHADA

REGUA ENCHIMENTO RECUADA

REGUA ENCHIMENTO E PORTA RECUADA

REMATE SUPERIOR
REGUA DE ENCHIMENTO

RODATETO INTERIOR

REMATE INFERIOR

REMATE POSTERIOR

ESTRUTURA SARRAFOS
FORNECIDO BARRAS 2600MM

DIMENSÕES A FORNECER EM TOSCO